

Motion & TH Sensor

Featuring LoRaWAN®

WS203

Milesight



The Milesight WS203 is an environmental monitoring device that combines motion and temperature/humidity (TH) sensors. By detecting motion within an 8-meter range based on passive infrared (PIR) technology, the WS203 can trigger TH detection and periodically report environmental status over LoRaWAN® network.

With easy configuration and wireless detection, the WS203 offers a reliable and convenient solution for space and TH optimization. Compatible with Milesight LoRaWAN® gateway, IoT Cloud platform and Milesight Development Platform, it enables real-time monitoring of occupant status for effective remote management.

The WS203 can find applications in various settings including smart offices, buildings, hospitals, and more.

◆ Features

- Equipped with passive infrared and Fresnel Lens for motion or occupancy detection
- Built-in high-accurate TH sensor along with PIR sensor enabling communicative triggers
- Provide different types of PIR covers for adjustable and flexible field angles and different detecting ranges
- V0 grade flame retardant material makes it adaptable to various scenarios, enhancing safety and reliability
- Store locally 1000 historical records and support retransmission to prevent data loss
- Equipped with NFC for one touch configuration and support card emulation mode
- Function well with standard LoRaWAN® gateways and network servers
- Compatible with Milesight IoT Cloud and Milesight Development Platform
- Support Milesight D2D protocol to enable ultra-low latency and direct control without a gateway

◆ Specifications

Wireless Transmission	
Technology	LoRaWAN [®] , Milesight D2D
Antenna	Internal Antenna
Frequency	CN470/IN865/EU868/RU864/US915/AU915/KR920/AS923-1&2&3&4
Tx Power	16 dBm (868 MHz)/20 dBm (915 MHz)/19 dBm (470 MHz)
Sensitivity	-137 dBm
Mode	OTAA/ABP Class A
Measurement	
PIR	
Detection Area	120 ° Horizontal, 100 ° Vertical
Detection Distance	Maximum 6 m
Temperature	
Range	-20°C ~ 60°C
Accuracy ^[1]	Typ. ±0.3°C (-20°C ~ 0°C), ± 0.2°C (0°C ~ 60°C)
Resolution	0.1°C
Humidity	
Range	0% ~ 100% RH
Accuracy ^{[2][3]}	Typ. ± 2% RH (25°C)
Resolution	0.5% RH
Others	
Button	1 × Power/Reset Button (Internal)
LED Indicator	1 × Status Indicator
Configuration	Mobile App via NFC or Downlink
Advanced Feature	Milesight D2D Controller, Data Storage (1,000 entries), Data Retransmission
Physical Characteristics	
Power Supply	1 × 4000 mAh ER18505 Li-SOCl ₂ Battery
Battery Life ^[4] (30 min report interval + 64 Triggers per Day, LED Disabled, 25°C)	Around 10.7 Years (SF7, EU868) Around 5.4 Years (SF10, EU868) Around 10.8 Years (SF7, US915) Around 5.2 Years (SF10, US915)
Operating Temperature	-20°C to +60°C

Relative Humidity	0 to 95% (Non-condensing)
Dimension	73 × 73 × 26 mm (2.87 × 2.87 × 1.02in) (Without PIR Cover)
Weight	89.6g (Battery Included)
Ingress Protection	IP30
Color & Material	White + Grey, PC + ABS (Flame Retardant, UL94 V0)
Installation	3M Tape Mounting, Wall Screw Mounting
Approvals	
Regulatory	CE, FCC
Environmental	RoHS

Note:

1. Accuracy corresponding to the temperature:

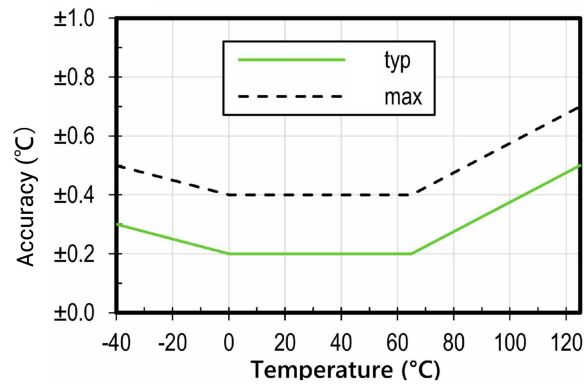

2. Accuracy corresponding to the relative humidity:

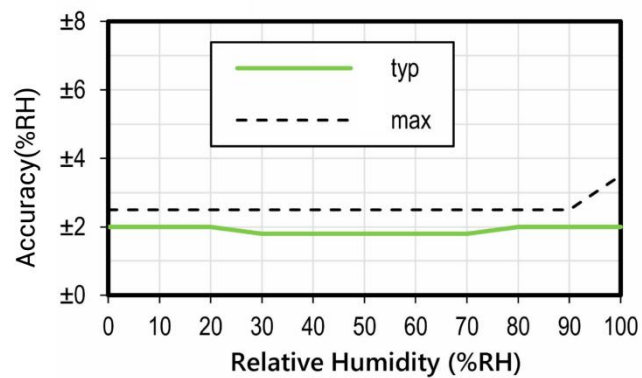

3. Typical RH accuracy corresponding to the temperature:

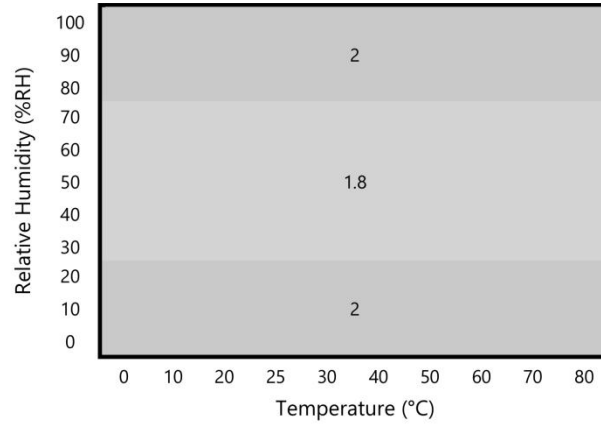



4. The battery life is tested under laboratory conditions and for guideline purposes only.

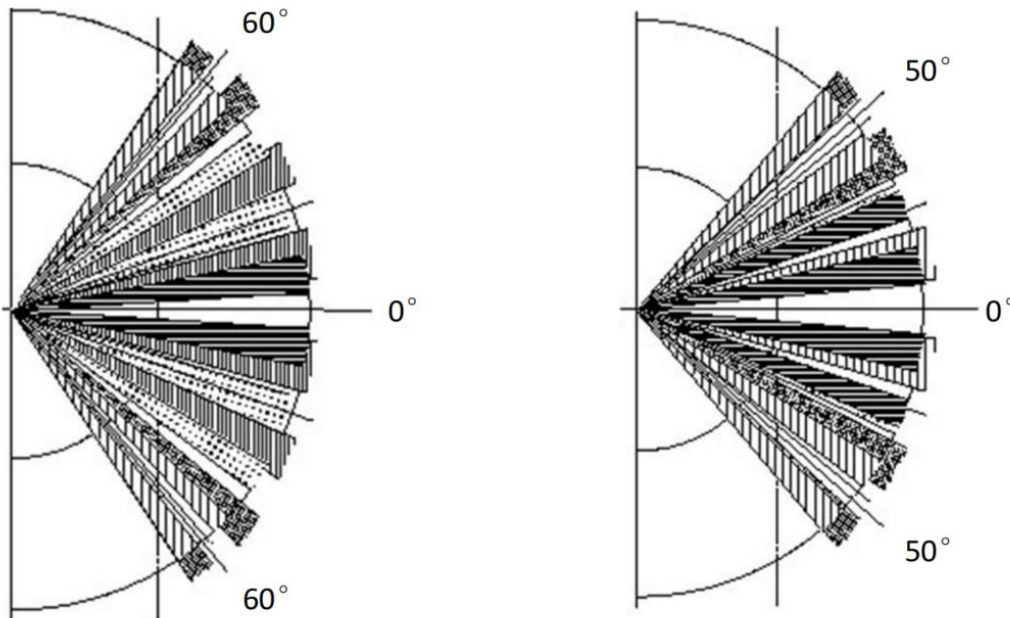

◆ PIR Area



◆ PIR Cover Reference Guidance

WS203 provides default PIR cover accessories for different detection areas. When the wall mounting installation height is 2m, the PIR detection area can be referred as below:

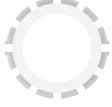
PIR Cover	Detection Area
	Maximum: 120 ° Horizontal, 50 ° Vertical, 6 m Recommend: 98 ° Horizontal, 44.4° Vertical, 5 m
	Maximum: 38 ° Horizontal, 50 ° Vertical, 6 m Recommend: 38 ° Horizontal, 44.4° Vertical, 5 m

	<p>Maximum: 38 ° Horizontal, 100 ° Vertical, 6 m Recommend: 38 ° Horizontal, 88.8° Vertical, 5 m</p>
	<p>Maximum: 120 ° Horizontal, 100 ° Vertical, 6 m Recommend: 98 ° Horizontal, 88.8° Vertical, 5 m</p>
	<p>Support to be tailored as required</p>

◆ Dimensions (mm)

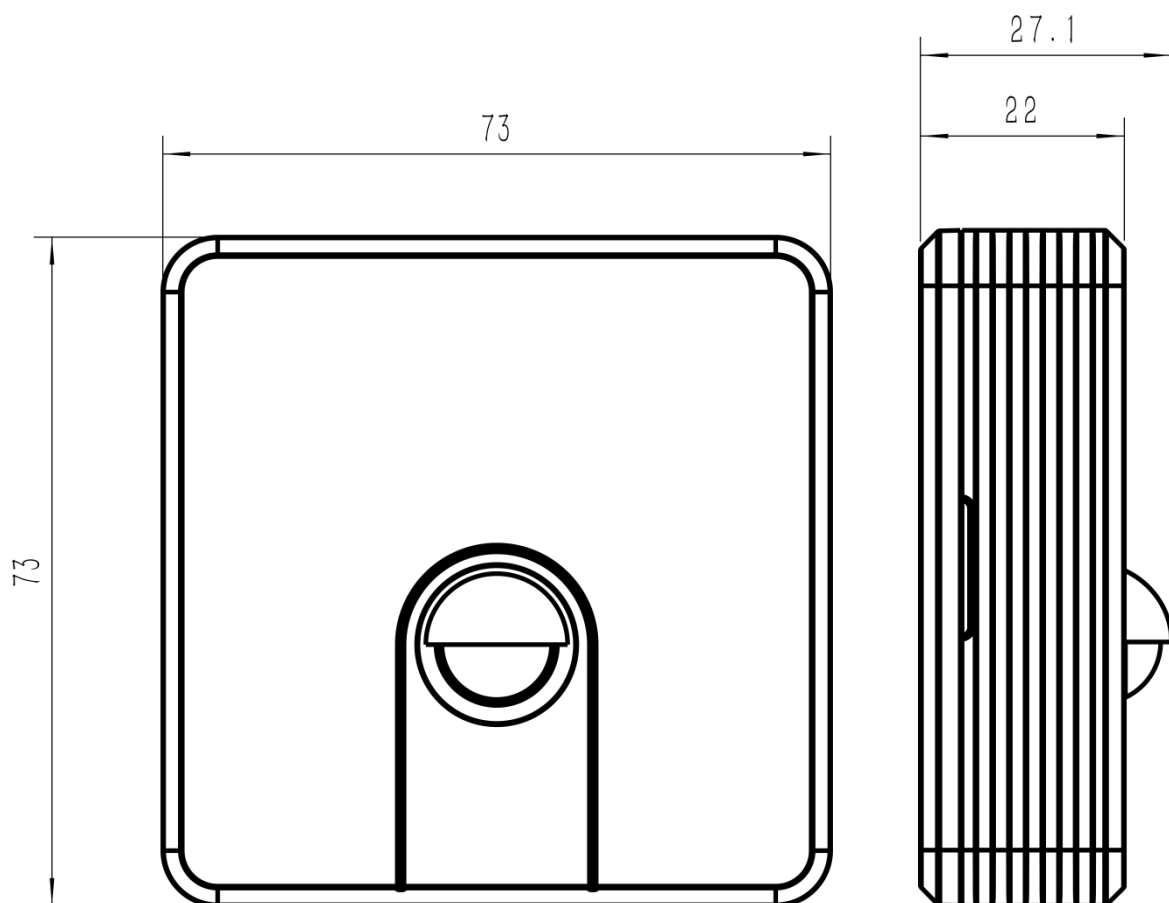

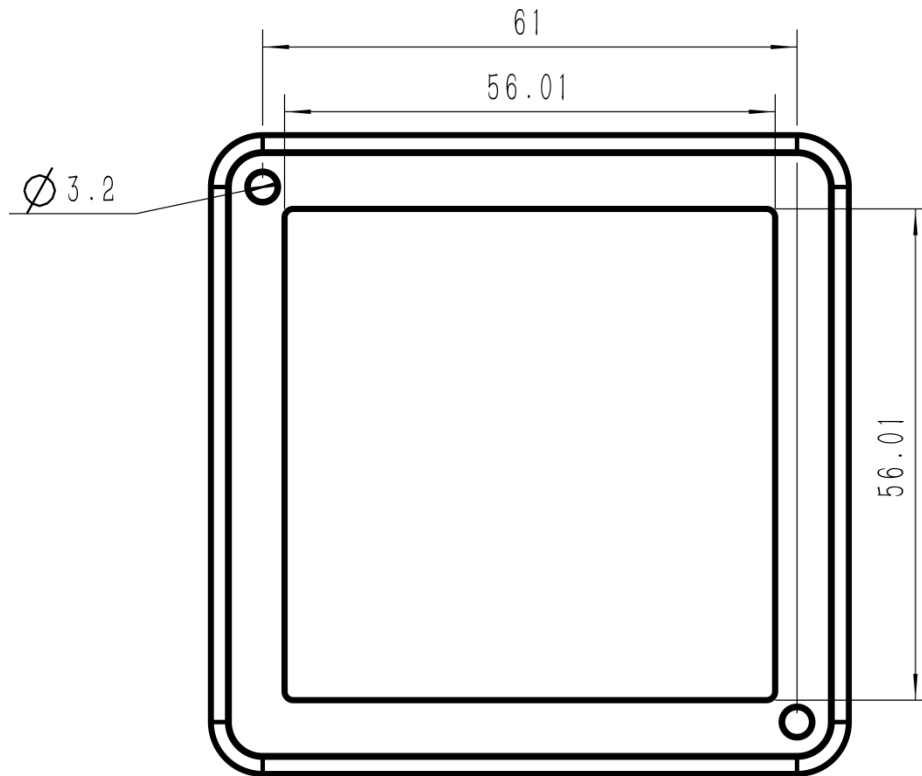

WELKO Av. Providencia 2330, Of. 63
+56 9 3174 3870 / +56 9 3427 0017
ventas@welko.cl - www.welko.cl

